

This drawing is HangOn AB property. It can't be reproduced or communicated without our written agreement

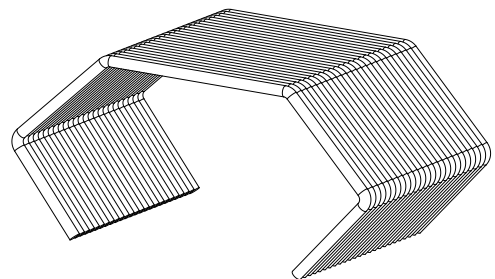
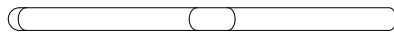
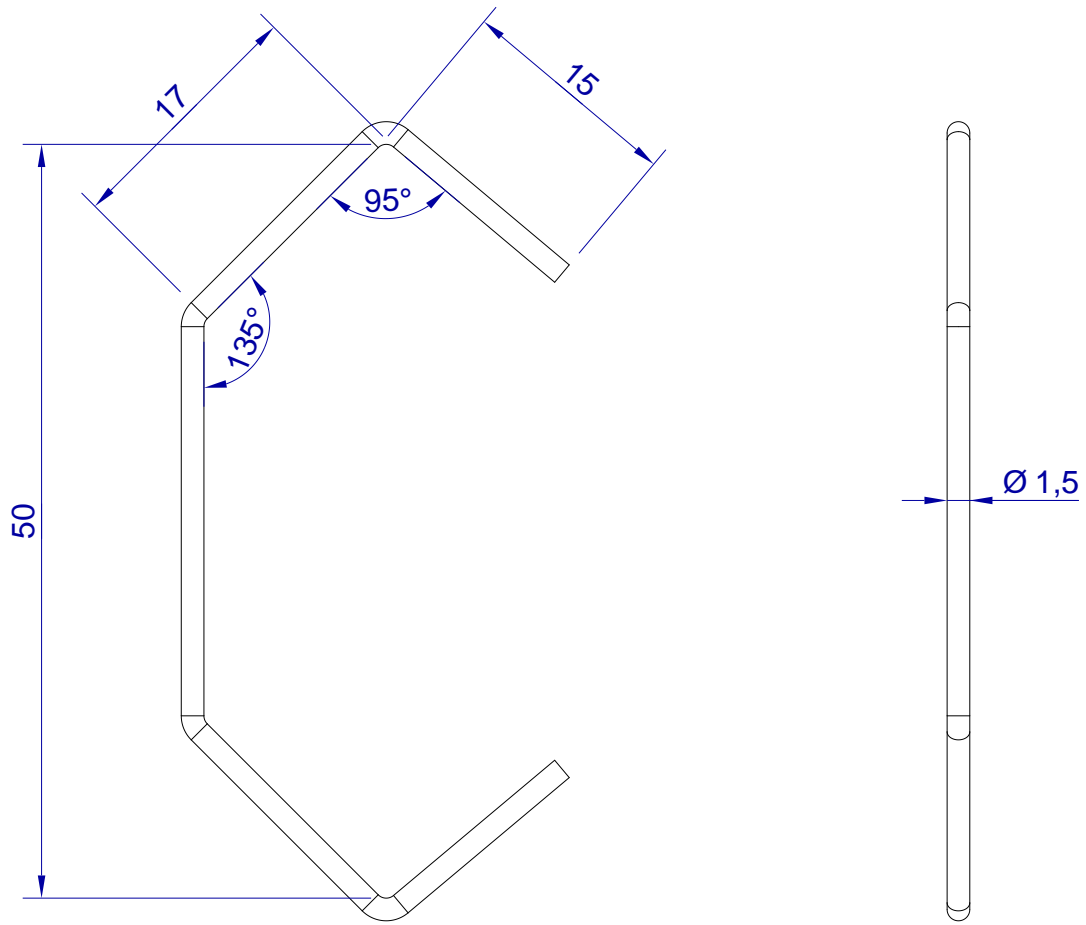

hang[®]
On

Product no.

F050X1,5 PDVX2

Description

Fixed hooks, stock item

2026-04-09 08:30