

This drawing is HangOn AB property. It can't be reproduced or communicated without our written agreement

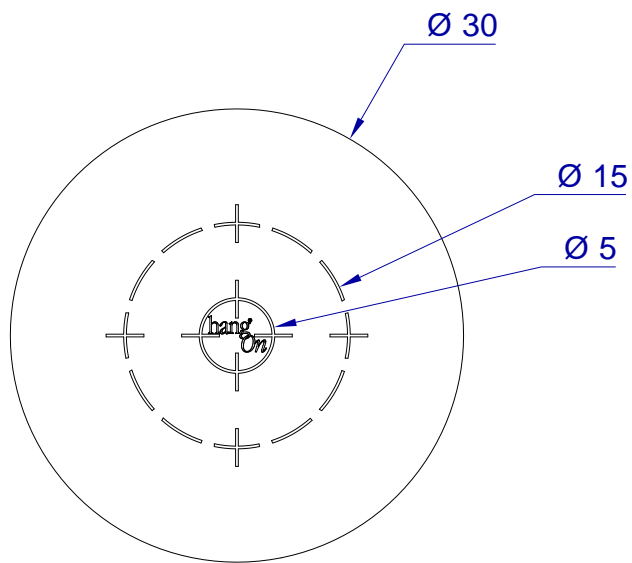

Product no.
ERX 030

Description
Disc with target rings and slit back